

F|S

FABRICS-STORE.COM

Our linen is nothing short of addicting

SKY DRESS



A CLASSIC STYLE FOR DECADES

The shirt dress is an absolute must have in every wardrobe. It is one of those garments that works for every season and situation.

Available in Ladies Sizes 0/2 to 28/30

866.620.2008 ASK@FABRICS-STORE.COM FABRICS-STORE.COM

SKY PATTERN

Our Sky sewing pattern is a classic gathered shirtdress with a modern twist and attention to detail. Cut in a flattering, timeless shape, our favorite thing about this design is the flap patch pockets and contrasting topstitching.

Sized for ladies 0/2 to 28/30

Simple step-by-step instructions on our blog [The Thread at Fabrics-Store.com](#)

MASHA IS WEARING IC64 BLACK SOFTENED - 100% LINEN (5.3 OZ/YD2)



Our lovely model Masha is wearing Size 4/6.

PATTERN DETAILS

#FABRICSSTORESKYPATTERN



SKY PATTERN

Ladies Duo Sizes: 0/2 to 28/30

- Loose fitting body.
- Semi-fitted, cuffed sleeves.
- Chest pockets.
- Gathered skirt.
- Button-front bodice.

SEWING INSTRUCTIONS

This pattern is featured on our blog “The Thread” at Fabrics-Store.com. There you will find step-by-step photo instructions and can ask questions, post comments, or share your progress. Simply visit: blog.fabrics-store.com and enter “Sky Pattern” in the search box.

SIZING & YARDAGE

Ladies Size Guide Based on Body Measurements in Inches

Size	0/2	4/6	8/10	12/14	16/18	20/22	24/26	28/30
Bust	33-34	35-36	37-38	39-40	42-44	46-48	50-52	54-56
Waist	25-26	27-28	29-30	31-32	34-36	38-40	42-44	46-48
Hip	35-36	37-38	39-40	41-42	44-46	48-50	52-54	56-58

Finished Garment Measurements - Approximate in Inches

Size	0/2	4/6	8/10	12/14	16/18	20/22	24/26	28/30
Bust	37	39	41.5	44	48	52	56.5	61
Waist	34	36	38.5	41	45	49	53.5	58
Hips	70	72	74.5	77	81	85	89.5	94

Estimated Yardage - 54" Width Linen*

Size	0/2	4/6	8/10	12/14	16/18	20/22	24/26	28/30
Yardage*	3 Yards			3.25 Yards		3.5 Yards		

*Allow up to 10% extra fabric for shrinkage.

ALL SEAM ALLOWANCES ARE INCLUDED AND NOTED ON THE PATTERN AND IN THE TUTORIAL.

“Sky” Sewing Pattern

For instructions visit: blog.fabrics-store.com and enter “Sky Pattern” in the search box.

2 Inch
Square to
Check Print
Accuracy

PRINT ONLY THIS PAGE FIRST TO CHECK SCALE

IMPORTANT! PRINT AT ACTUAL SIZE, 100%, OR NO SCALING.

Formatted for paper sizes A4 and Letter.

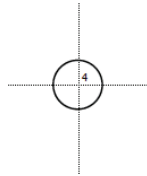

Simply overlap the page margins and align the markings in each corner to complete the circle and tape in place.

Layered PDF:
This pattern has embedded layers so you can print all sizes or a single size. See your .pdf viewers 'Layers' menu.

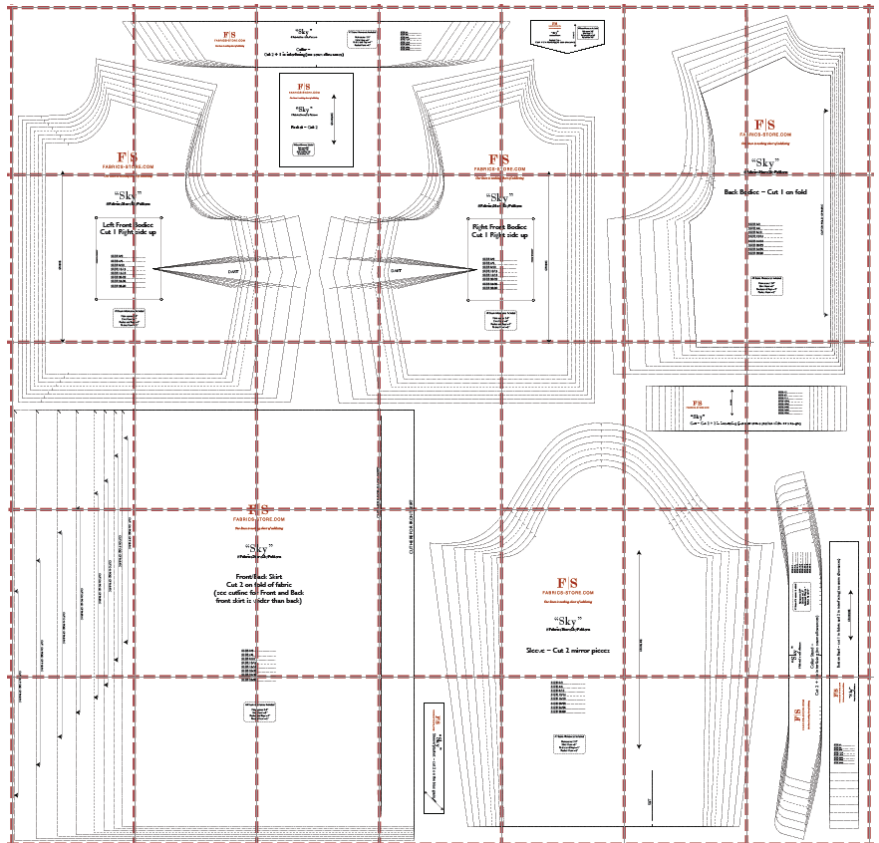

All Seam Allowances Included

- Main seams: 3/8"
- Skirt Hem: 1.5"
- Pocket and Flap: 1/4"
- Pocket Hem: 1/2"

For instructions visit: blog.fabrics-store.com and enter “Sky Pattern” in the search box.

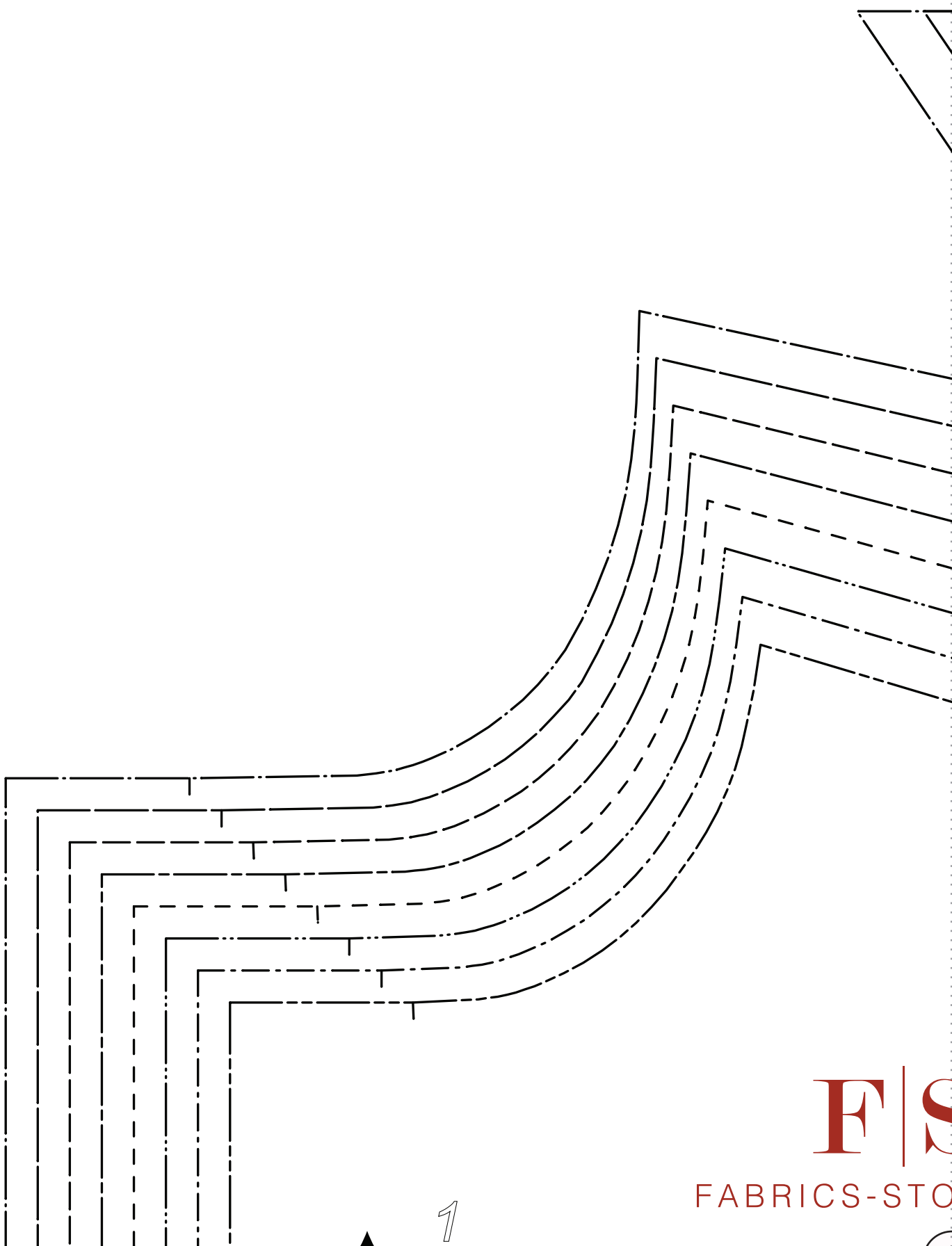

1

F|S
FABRICS-STO

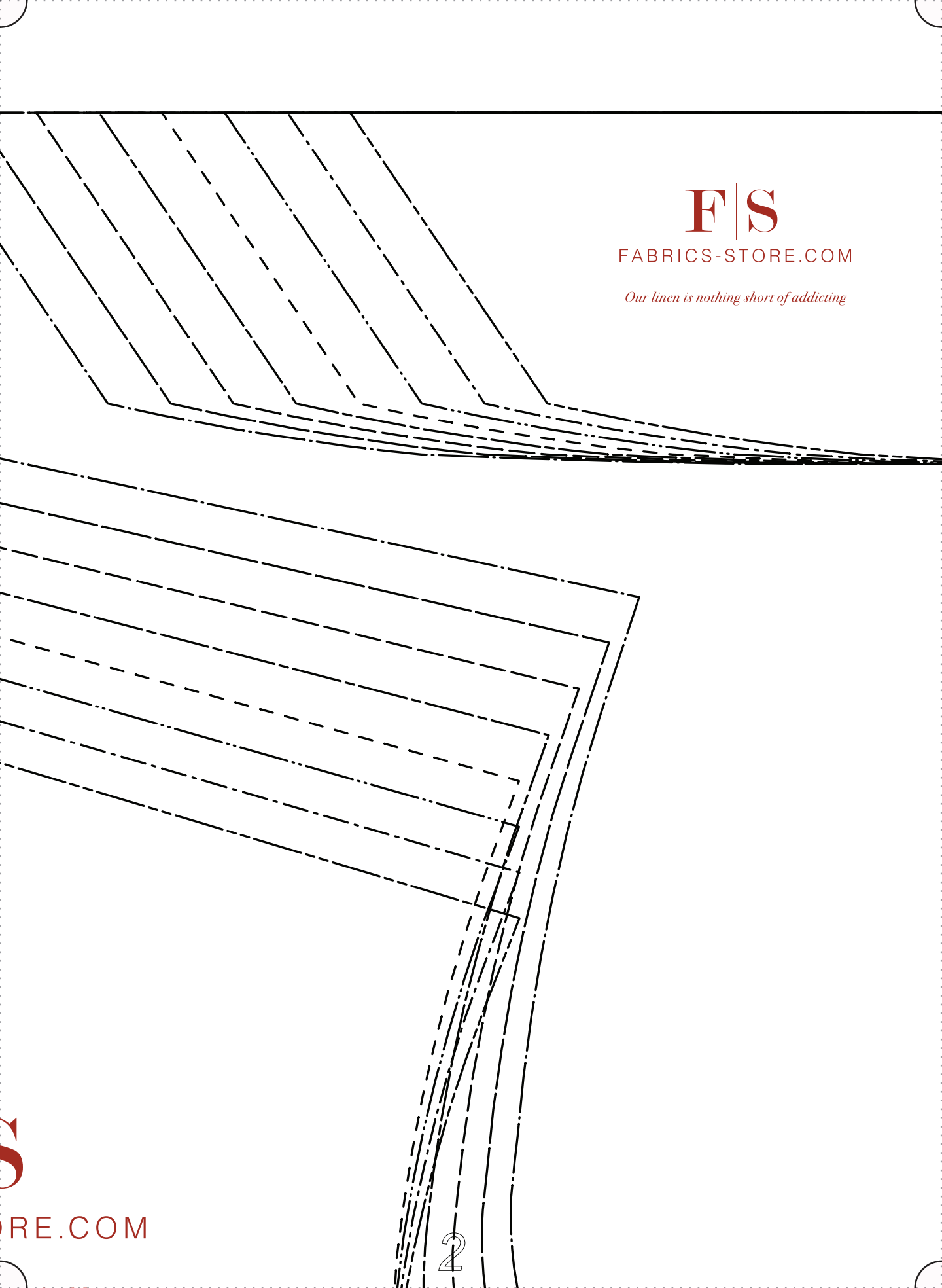

F|S

FABRICS-STORE.COM

Our linen is nothing short of addicting

S

RE.COM

“Sky”

#FabricsStoreSkyPattern

All Seam Allowances Included

Main seams: 3/8"
Skirt Hem: 1.5"
Pocket and Flap: 1/4"
Pocket Hem: 1/2"

Collar –
Cut 2 + 1 in interfacing (no seam allowances)

F|S

FABRICS-STORE.COM

Our linen is nothing short of addicting

“Sky”

#FabricsStoreSkyPattern

Pocket – Cut 2

GRAINLINE

All Seam Allowances Included

Main seams: 3/8"
Skirt Hem: 1.5"
Pocket and Flap: 1/4"
Pocket Hem: 1/2"

SIZE 0/2
SIZE 4/6
SIZE 8/10
SIZE 12/14
SIZE 16/18
SIZE 20/22
SIZE 24/26
SIZE 28/30

F|S

FABRICS-STORE.COM

Our lines is nothing short of addicting

“Sky”

#FabricStoreSkyPattern

Pocket Flap –

Cut 4 + 2 in interfacing (no seam allowances)

GRAINLINE

All Seam Allowances Included

Main seams: 3/8"

Skirt Hem: 1.5"

Pocket and Flap: 1/4"

Pocket Hem: 1/2"

S

FABRICS-STORE.COM

5

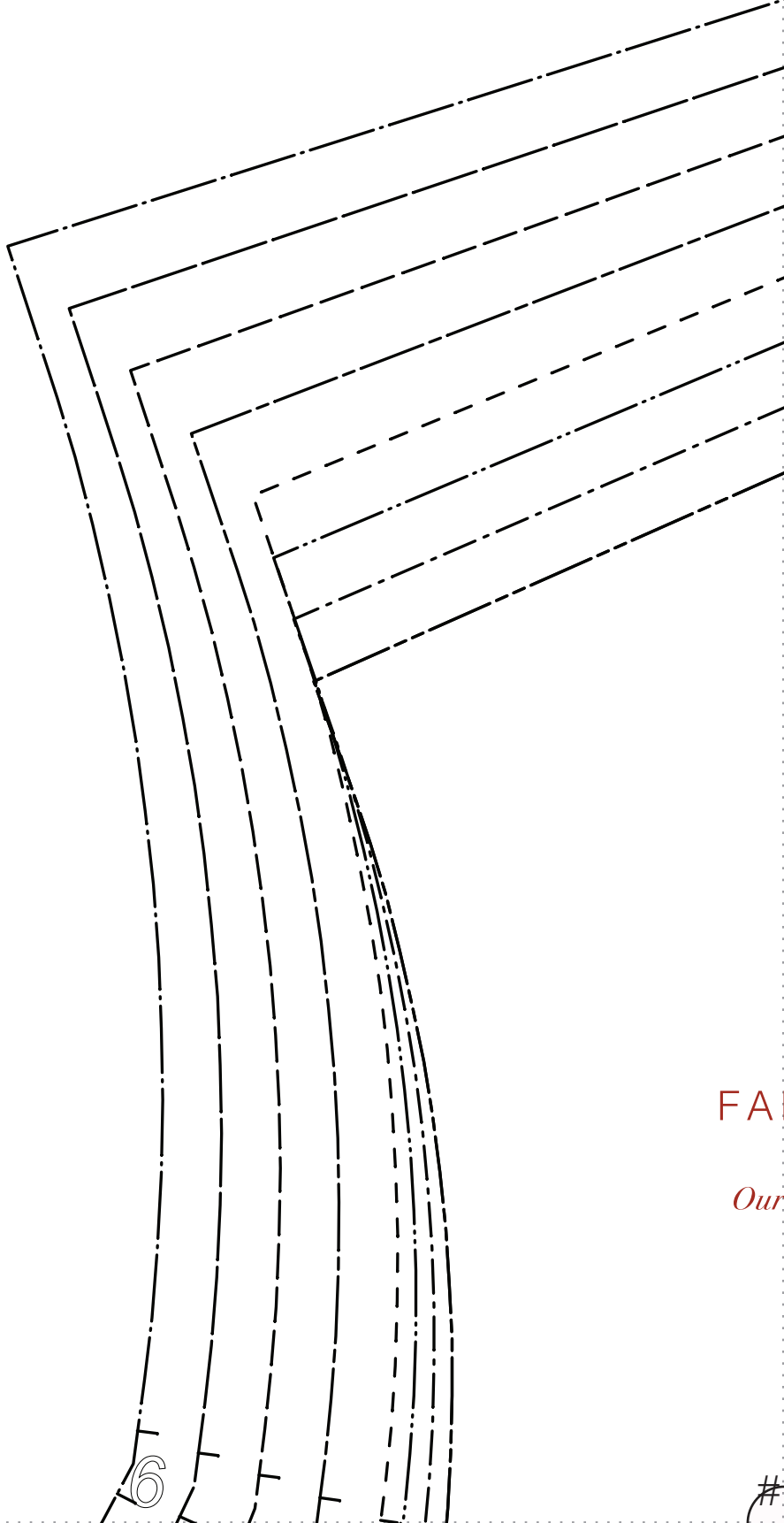

FA

Our



F|S

FABRICS-STORE.COM

linen is nothing short of addicting

“Sky”

FabricsStoreSkyPattern

7

“Sky

#FabricsStoreSk

Left Front Cut | Right

GRAINLINE

POCKET PLACEMENT

SIZE 0/2

SIZE 4/6

SIZE 8/10

SIZE 12/14

SIZE 16/18

SIZE 20/22

SIZE 24/26

SIZE 28/30

All Seam Allowances

Main seams: 3/8"

Skirt Hem: 1 1/2"

Pocket and Flap: 5/8"

Pocket Hem: 1/2"

”
V
kyPattern

Bodice
side up

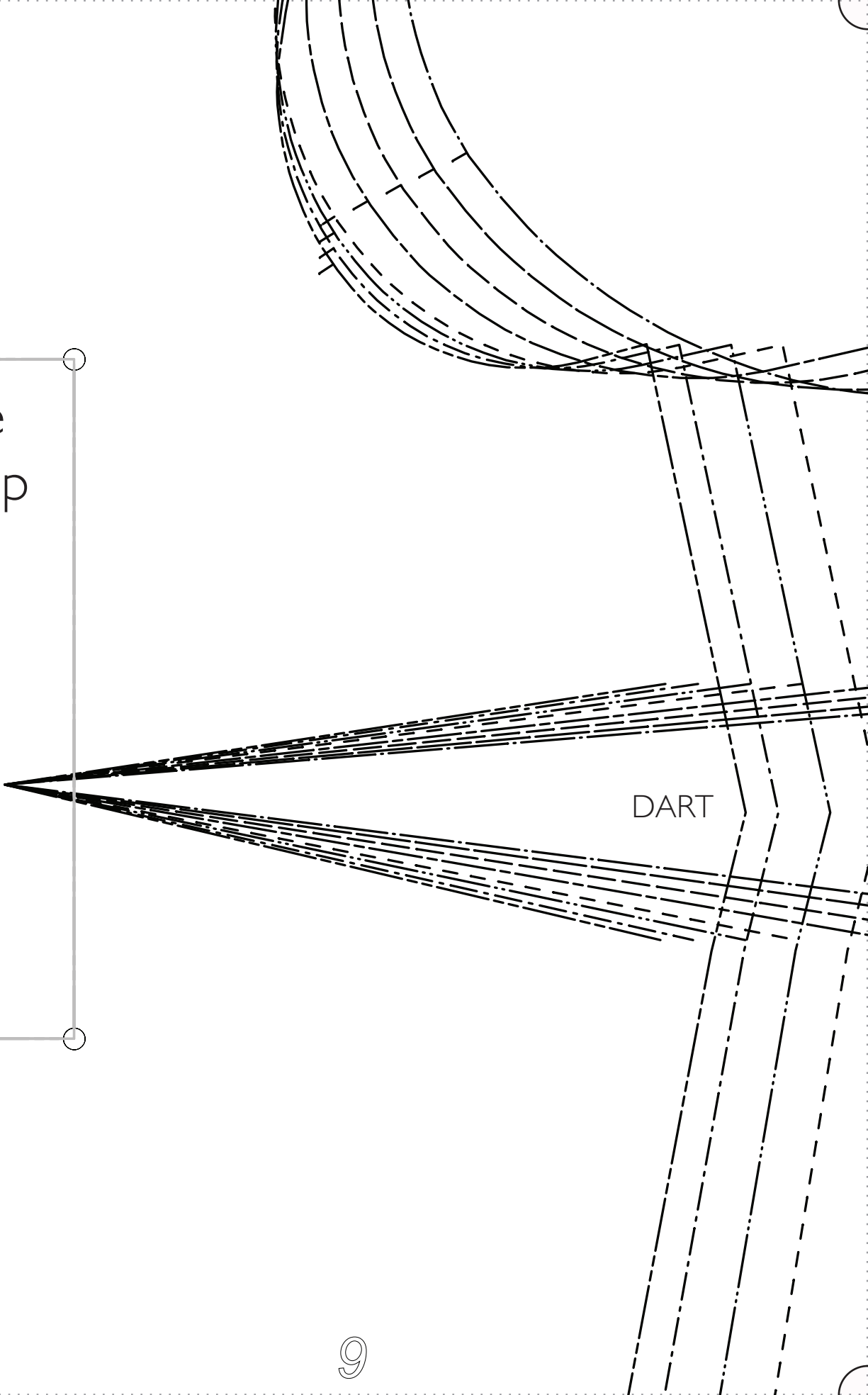
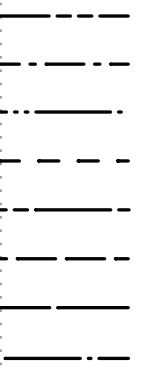

DART

s Included
3/8"
5"
: 1/4"
1/2"

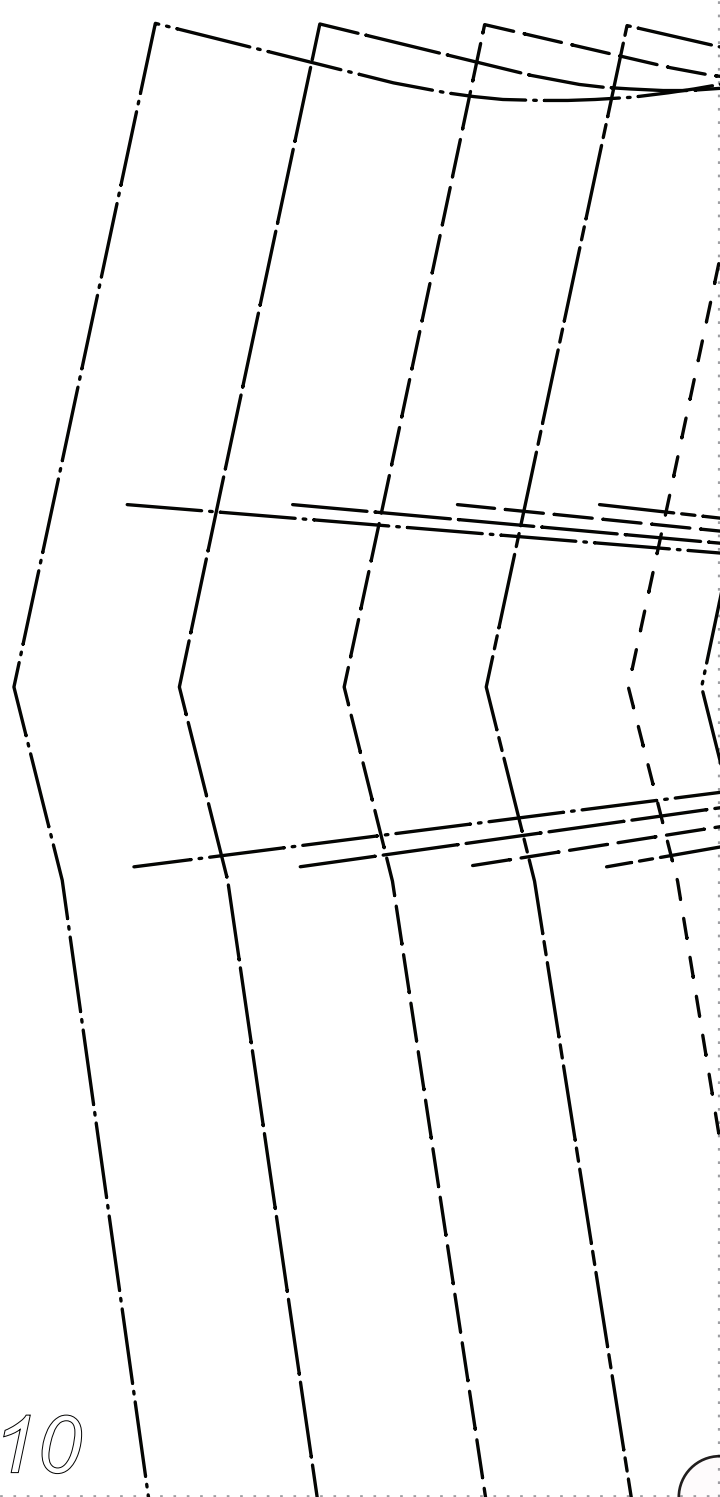
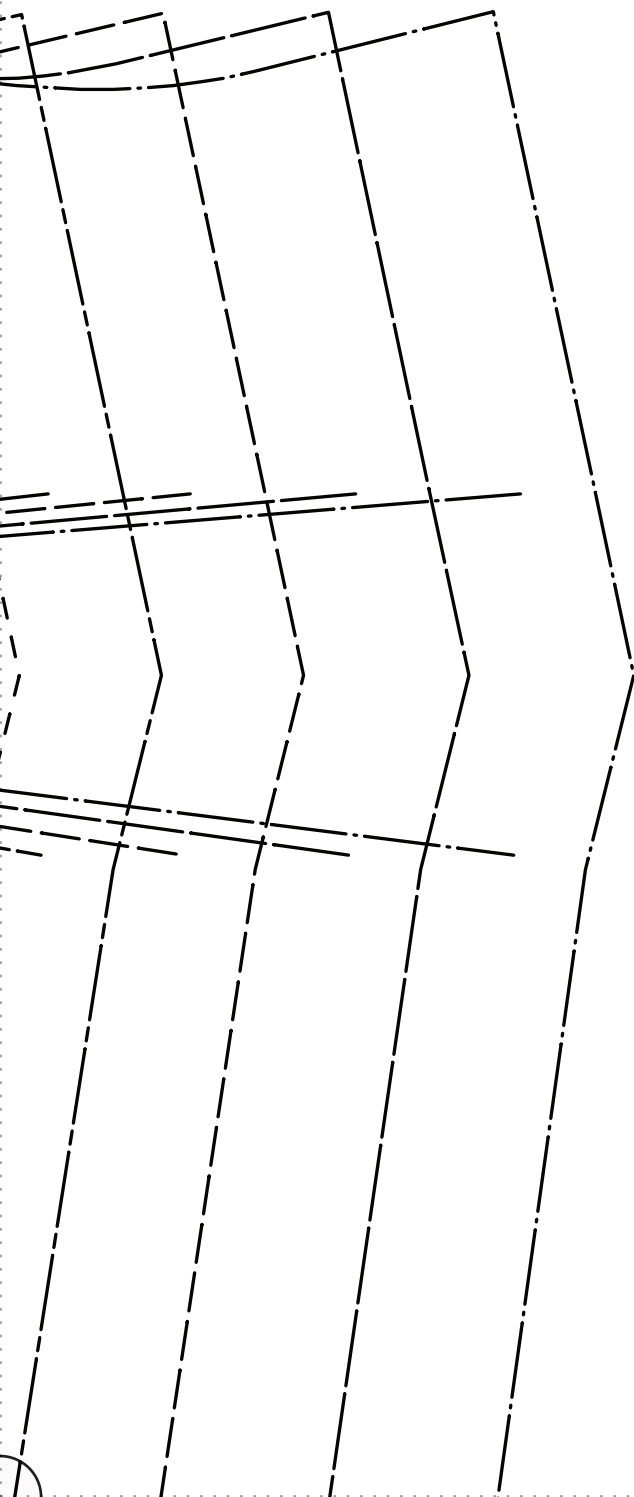

Our linen is nothing

“Sk

#FabricsStore

Right Front
Cut 1 Right

SIZE 0/2

SIZE 4/6

SIZE 8/10

SIZE 12/14

SIZE 16/18

SIZE 20/22

SIZE 24/26

SIZE 28/30

DART

All Seam Allowances

Main seam
Skirt Hem
Pocket and
Pocket Hem

short of adding

y”
eSkyPattern

nt Bodice
nt side up

POCKET PLACEMENT

GRAINLINE

ances Included

ms: 3/8"
m: 1.5"
Flap: 1/4"
em: 1/2"

Back Bo

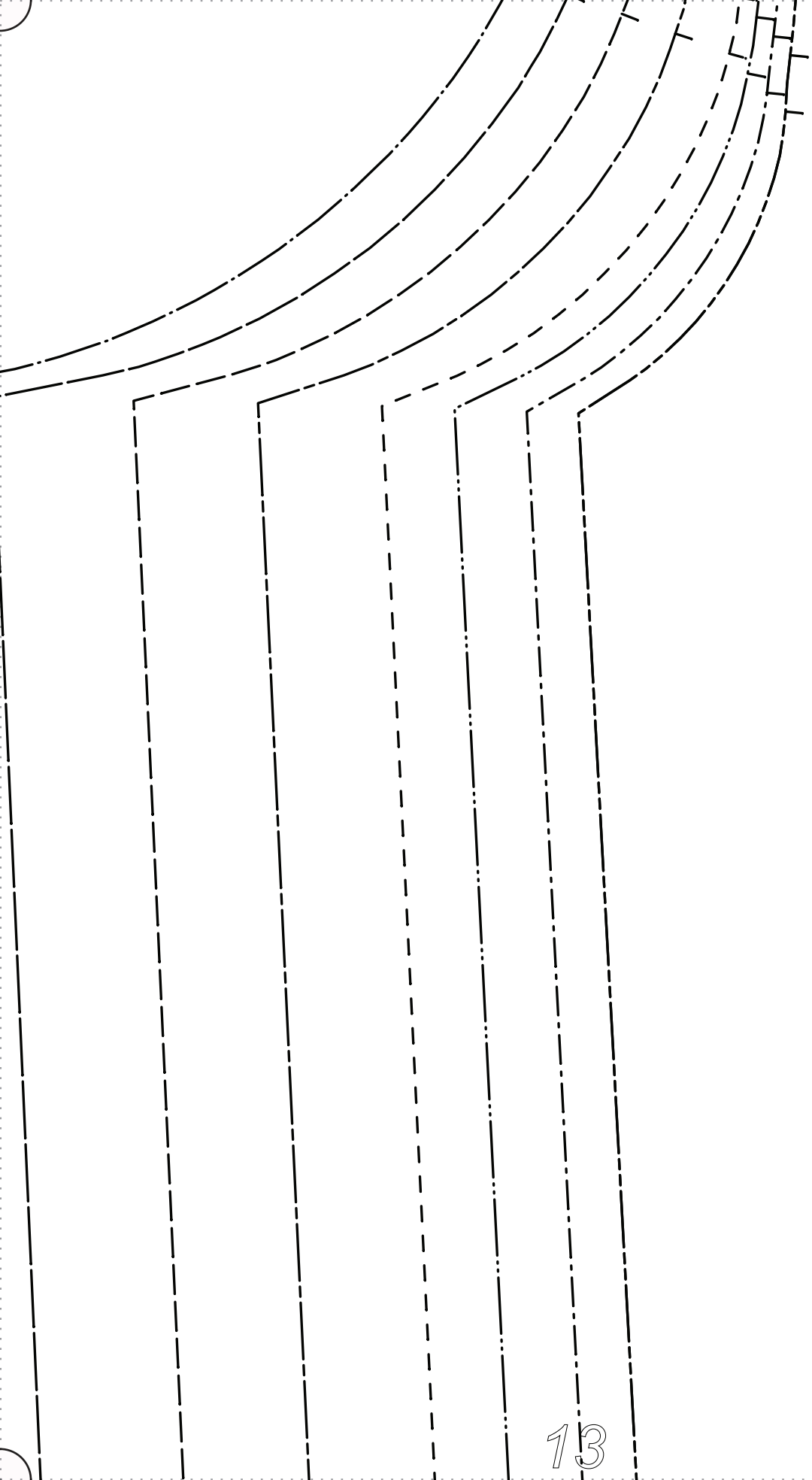

Podice – Cut 1 on fold

SIZE 0/2 _____

SIZE 4/6 _____

SIZE 8/10 _____

SIZE 12/14 _____

SIZE 16/18 _____

SIZE 20/22 _____

SIZE 24/26 _____

SIZE 28/30 _____

CUT ON FOLD OF FABRIC

All Seam Allowances Included

Main seams: 3/8"

Skirt Hem: 1.5"

Pocket and Flap: 1/4"

Pocket Hem: 1/2"

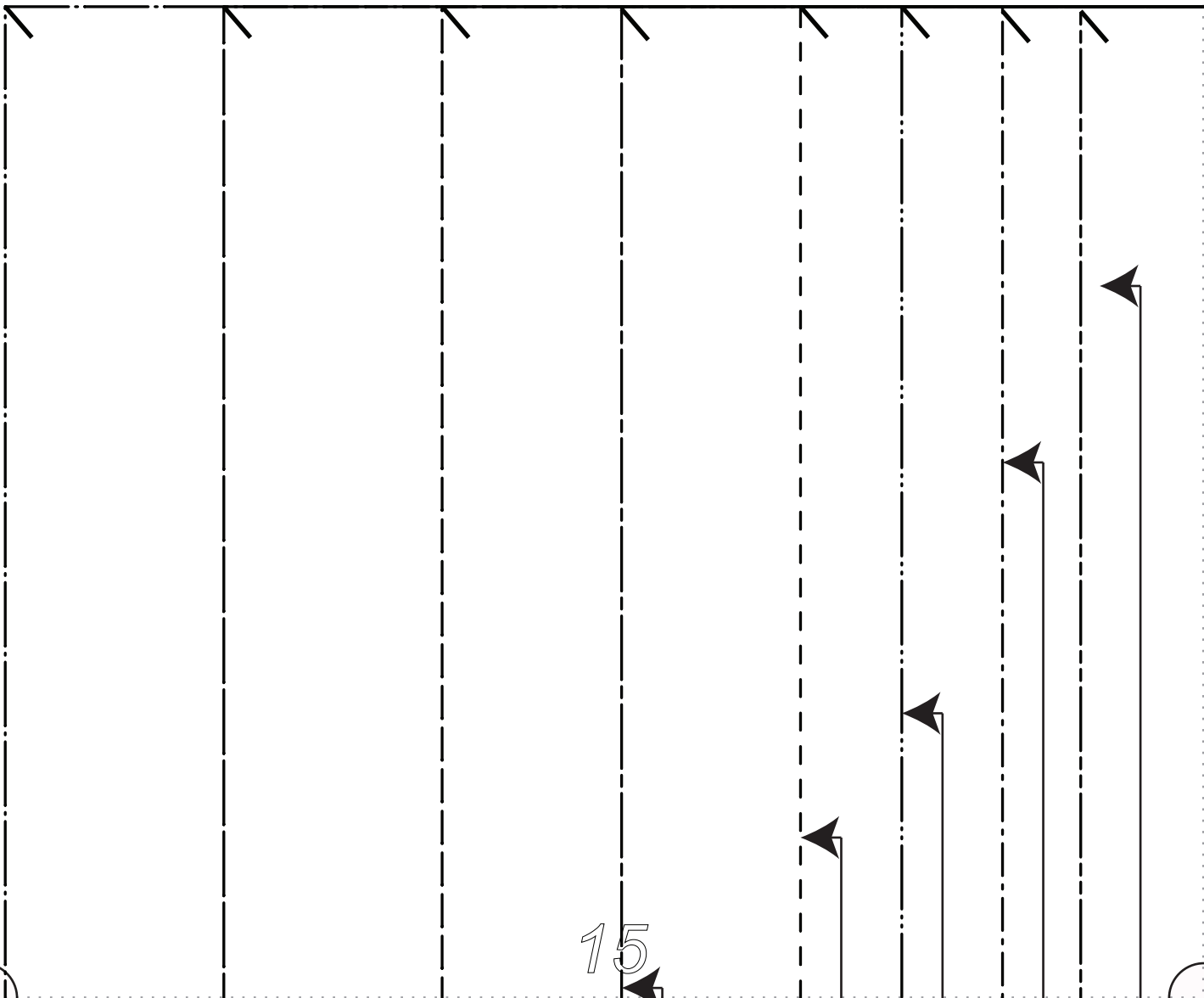
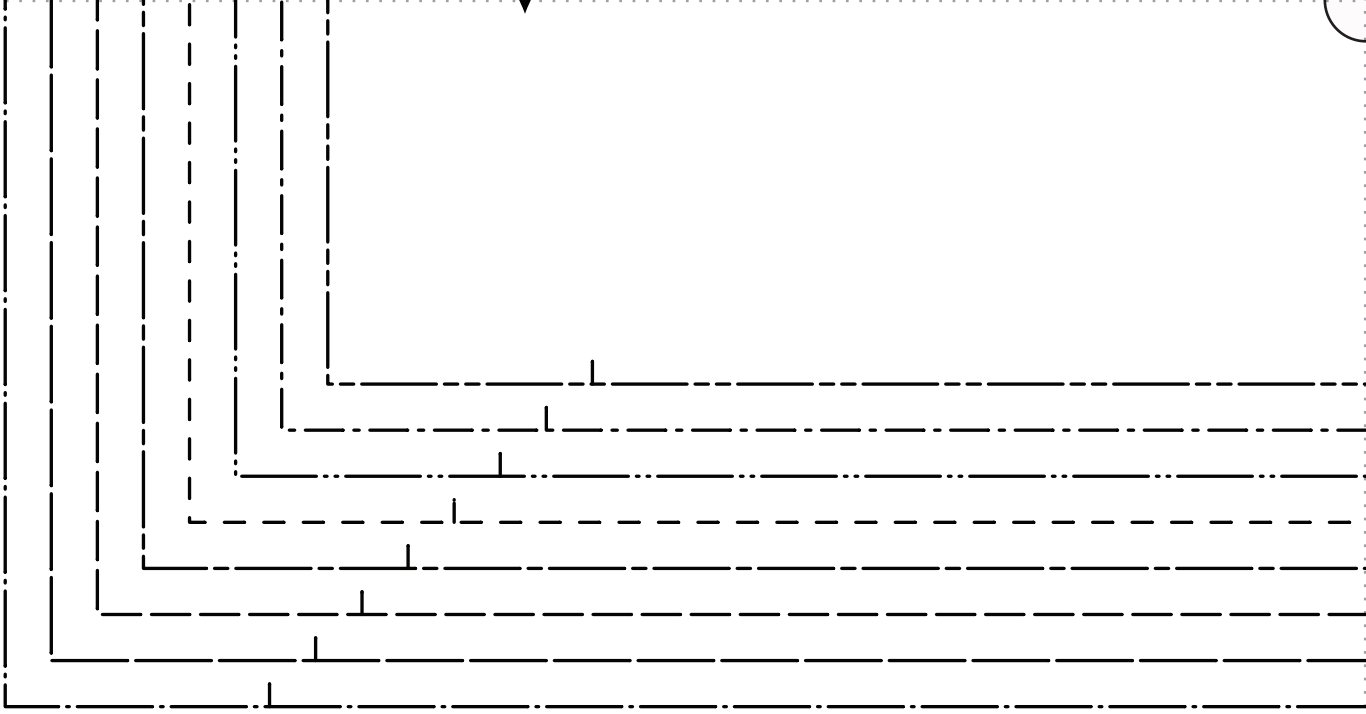

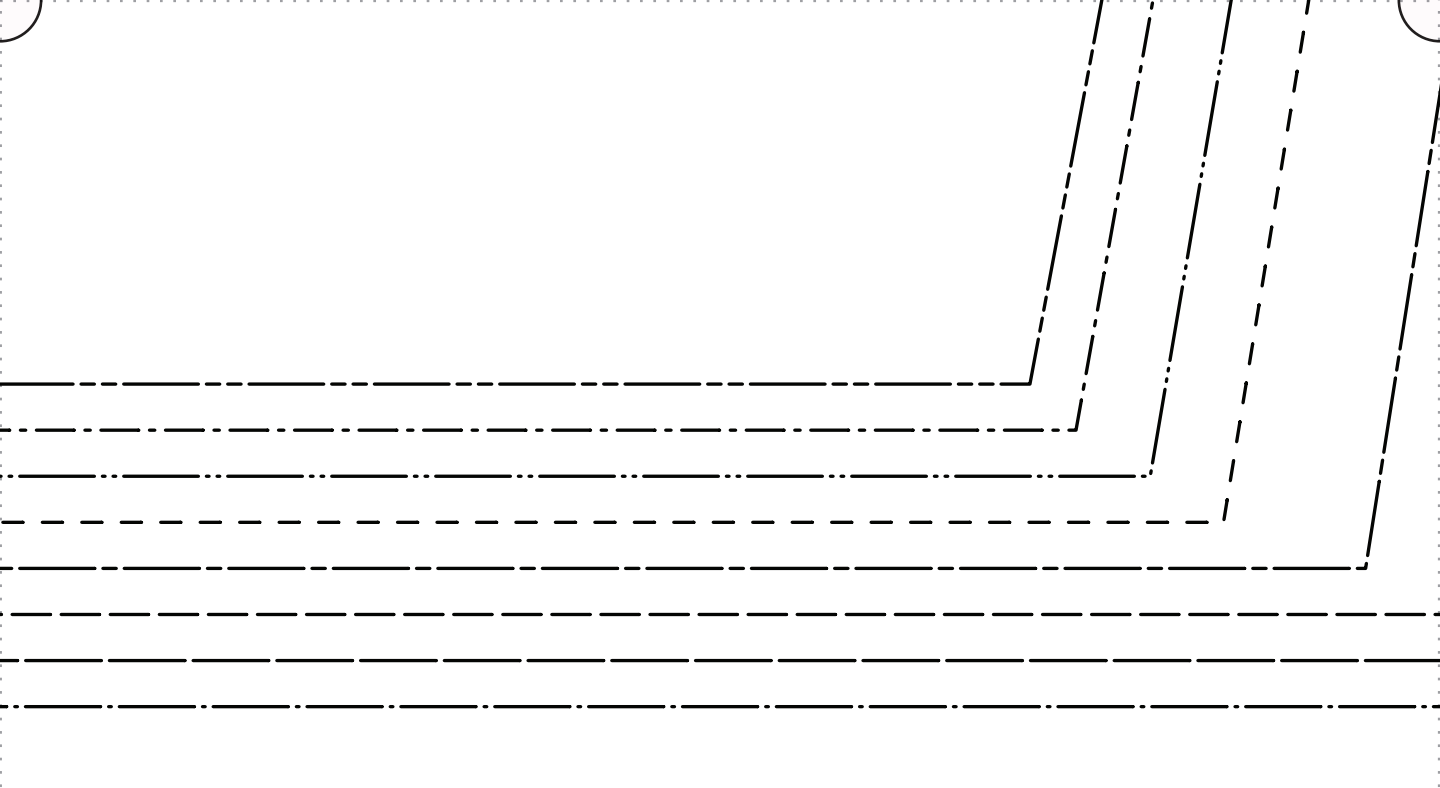

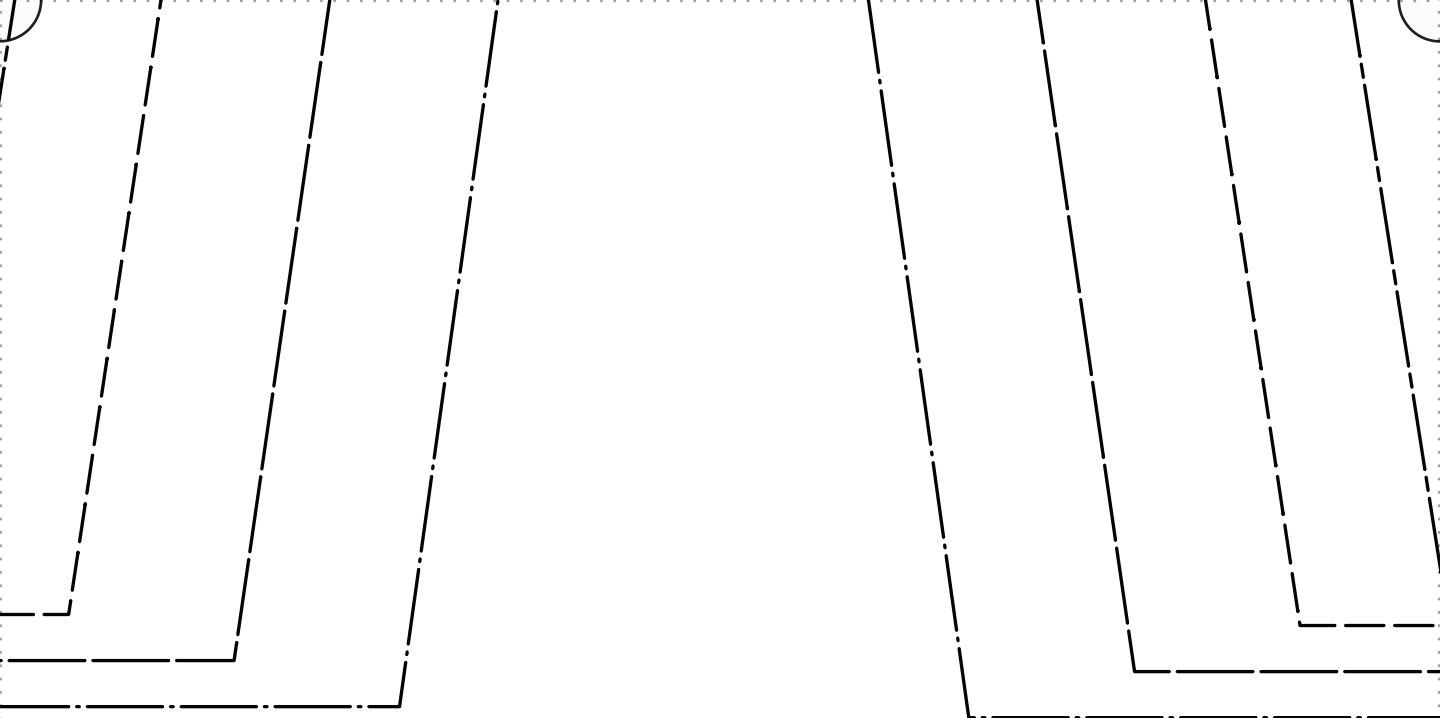

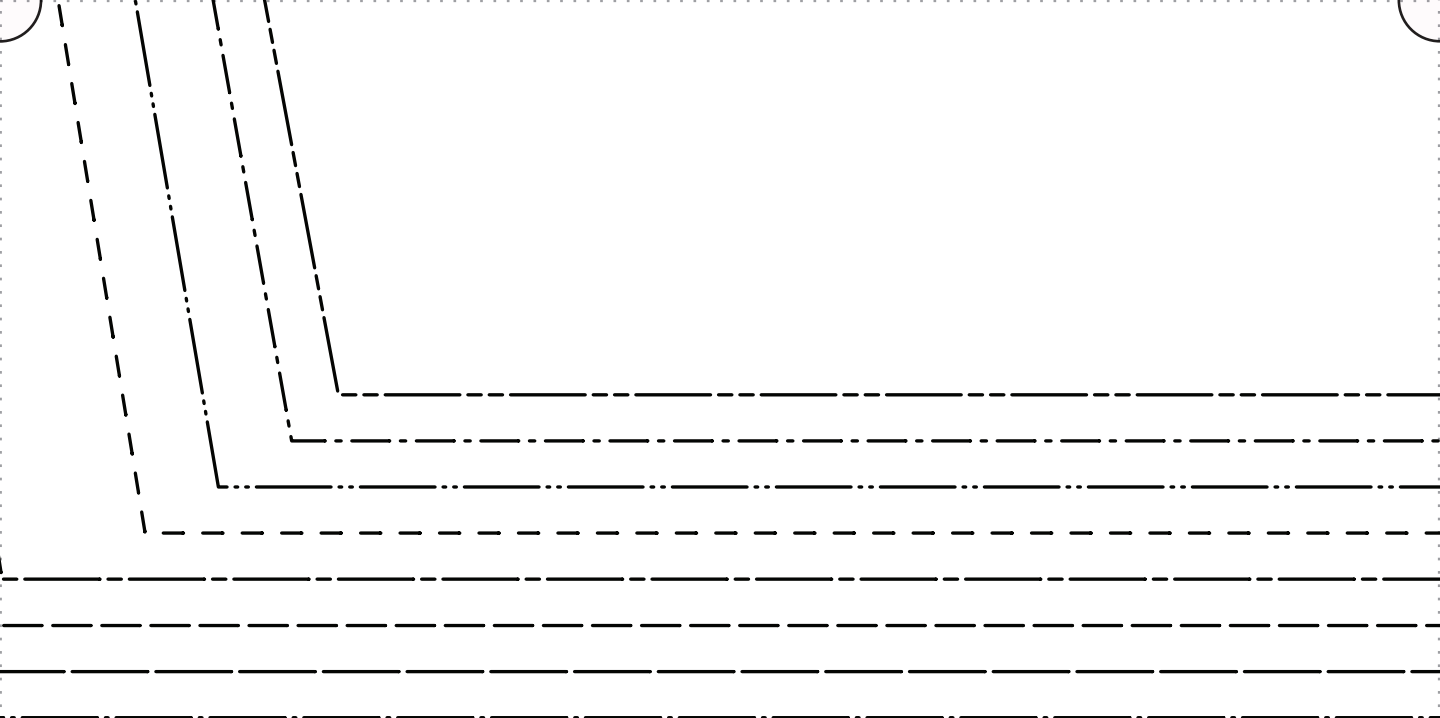

SKIRT

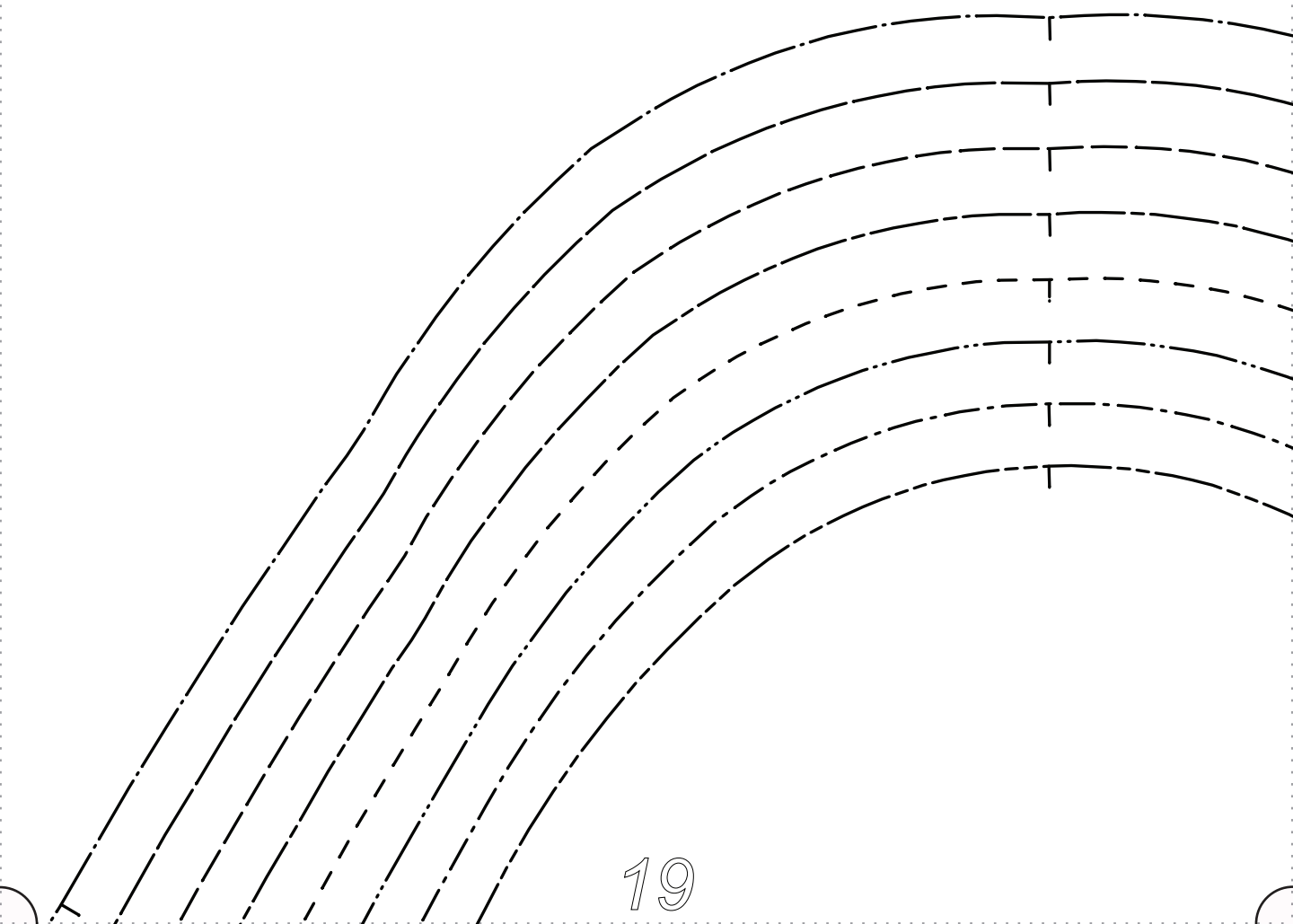
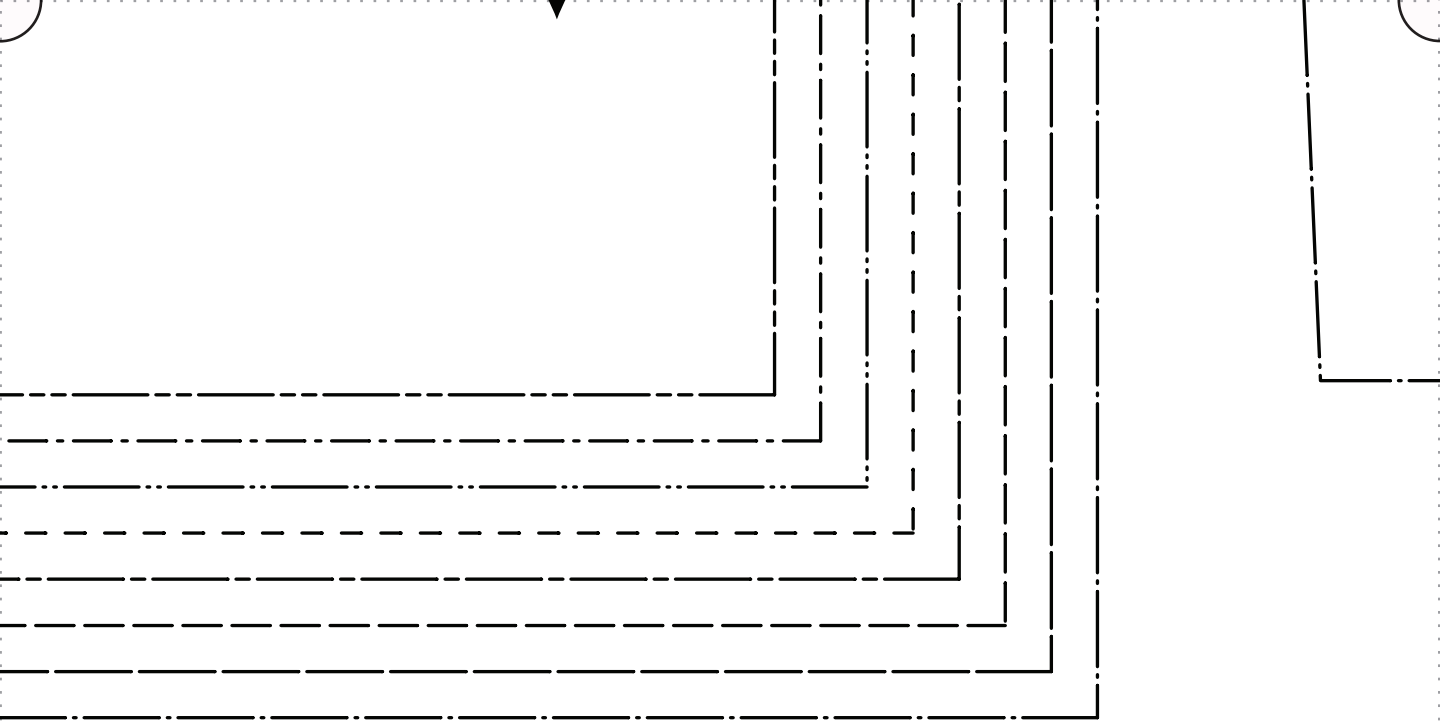

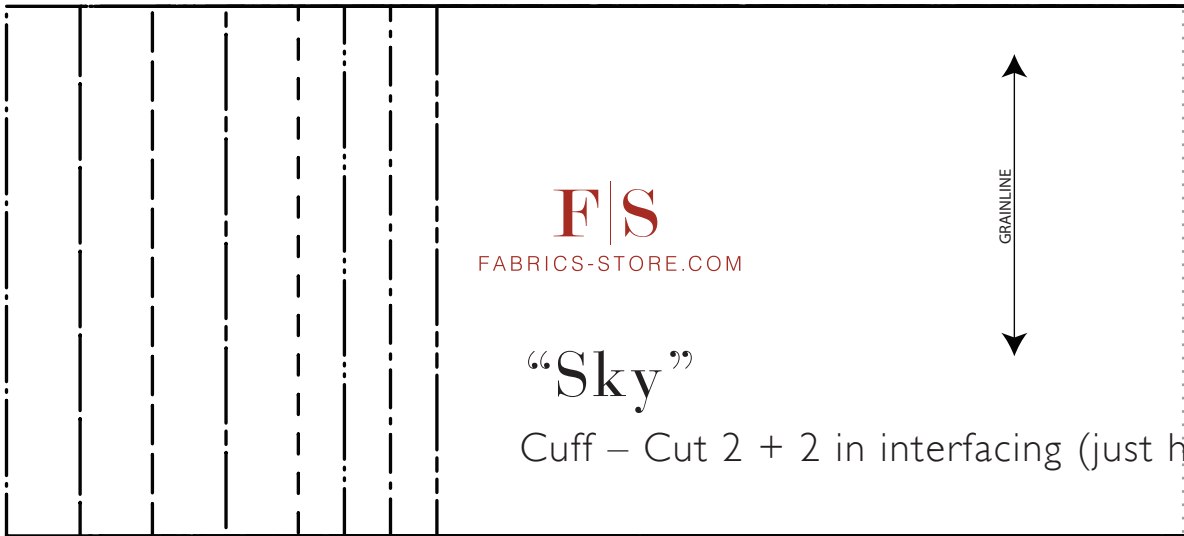
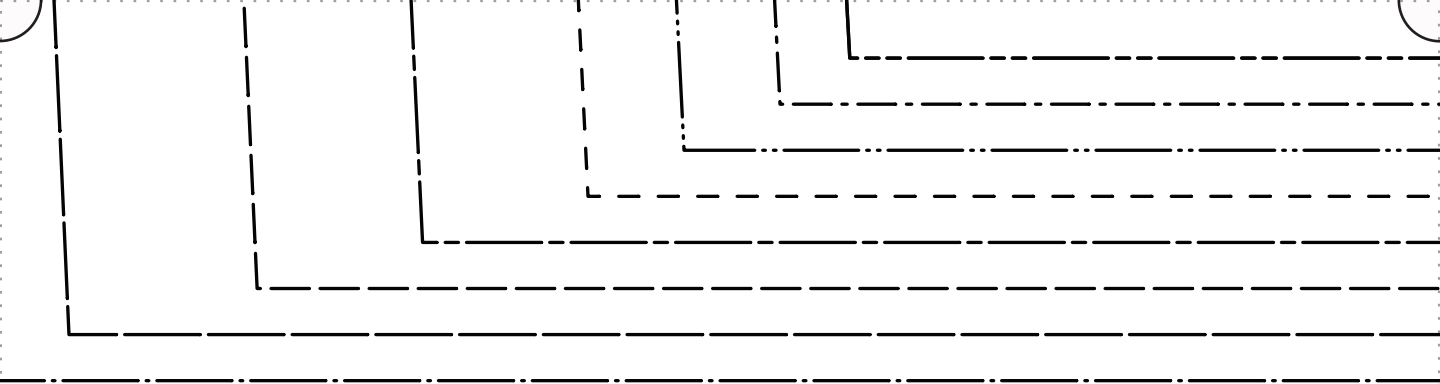

F|S
FABRICS-STORE.COM

“Sky”

Cuff – Cut 2 + 2 in interfacing (just h

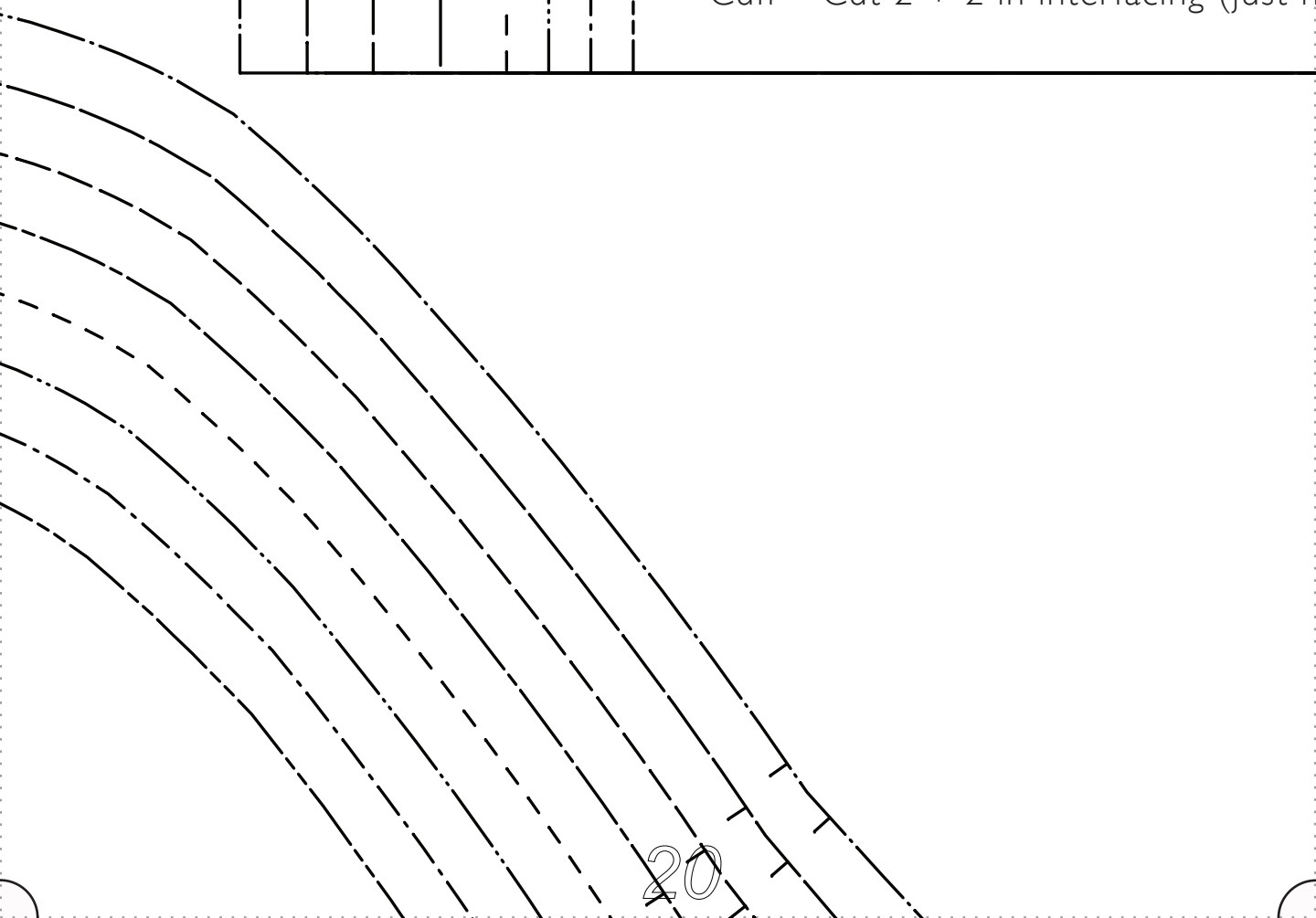

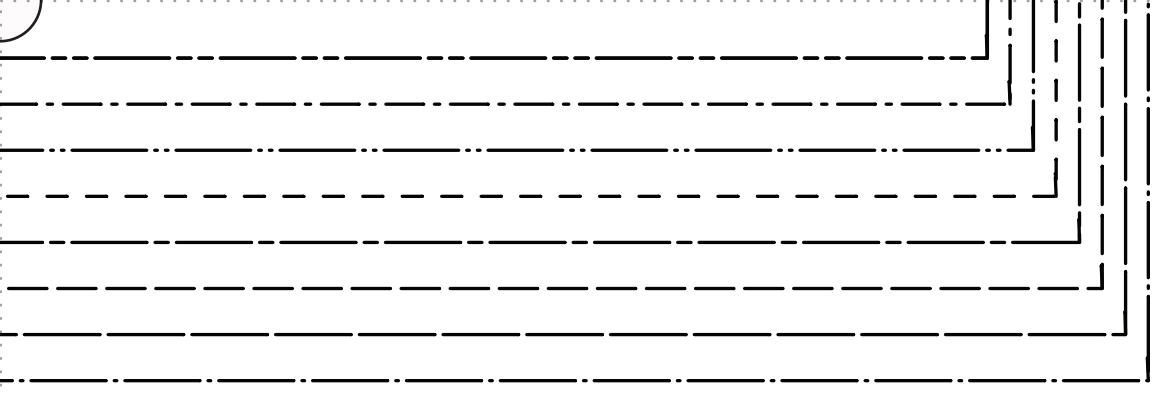

- SIZE 0/2 _____
- SIZE 4/6 _____
- SIZE 8/10 _____
- SIZE 12/14 _____
- SIZE 16/18 _____
- SIZE 20/22 _____
- SIZE 24/26 _____
- SIZE 28/30 _____

half of the placket width 1" x length)

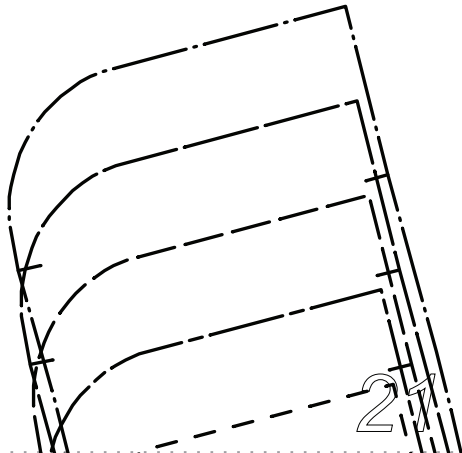
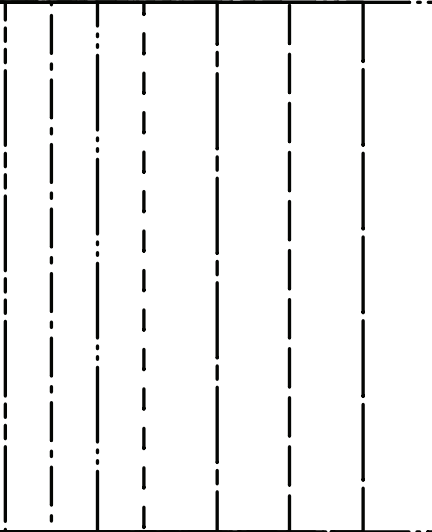

CUT ON FOLD OF FABRIC

CUT ON FOLD OF FABRIC

CUT ON FOLD OF FABRIC

CUT ON FOLD OF FABRIC

CUT ON FOLD OF FABRIC

CUT ON FOLD OF FABRIC

CUT ON FOLD OF FABRIC

CUT

Our linen is nothing

“S

#FabricsSto

Front/B

Cut 2 on f

(see cutline for

front skirt is w

SIZE 0/2SIZE 4/6SIZE 8/10SIZE 12/14SIZE 16/18SIZE 20/22SIZE 24/26

ing short of addicting

ky”
oreSkyPattern

Back Skirt
fold of fabric
Front and Back
(wider than back)

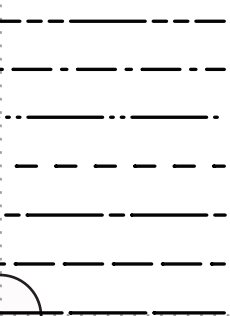

CUT HERE FOR FRONT

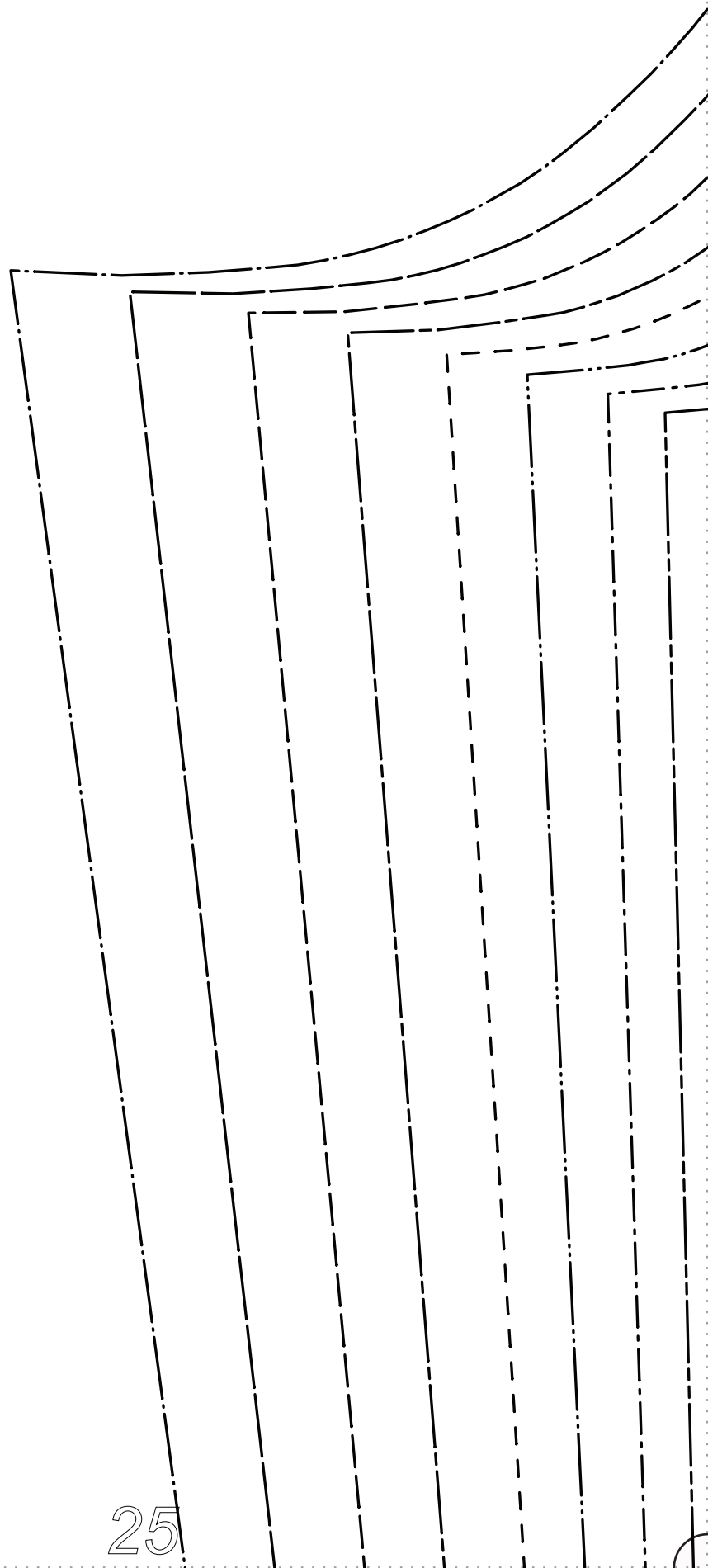



F|S

FABRICS-STORE.COM

Our linen is nothing short of addicting

“Sky”

#FabricStoreSkyPattern

Sleeve – Cut 2 mirror pieces



GRAINLINE

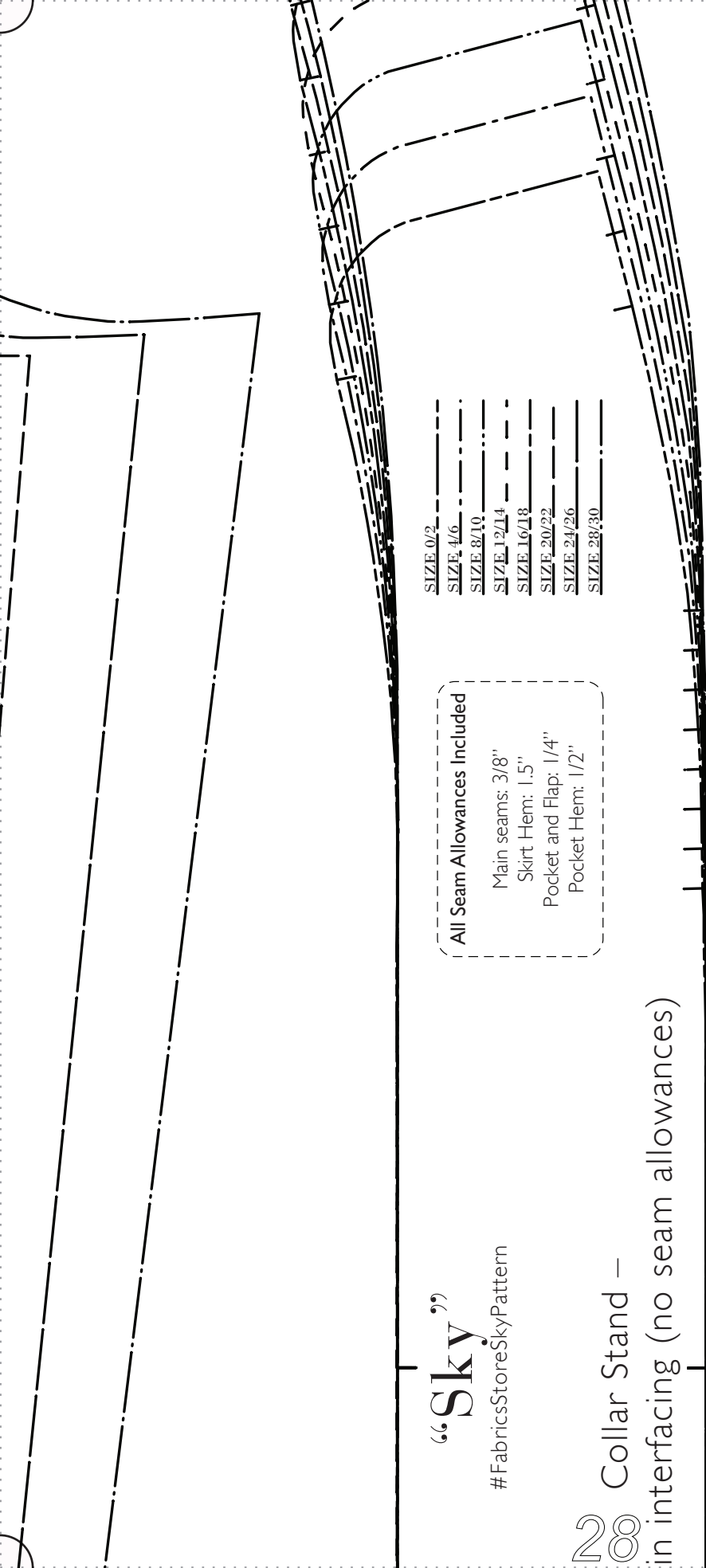

“Sky”

#FabricsStoreSkyPattern

200 Collar Stand –
in interfacing (no seam allowances)

- SIZE 0/2
- SIZE 4/6
- SIZE 8/10
- SIZE 12/14
- SIZE 16/18
- SIZE 20/22
- SIZE 24/26
- SIZE 28/30

All Seam Allowances Included

- Main seams: 3/8"
- Skirt Hem: 1.5"
- Pocket and Flap: 1/4"
- Pocket Hem: 1/2"

Button Band – cut 1 in fabric and 2 in interfacing (no seam allowances)

GRAINLINE

ON FOLD OF FABRIC

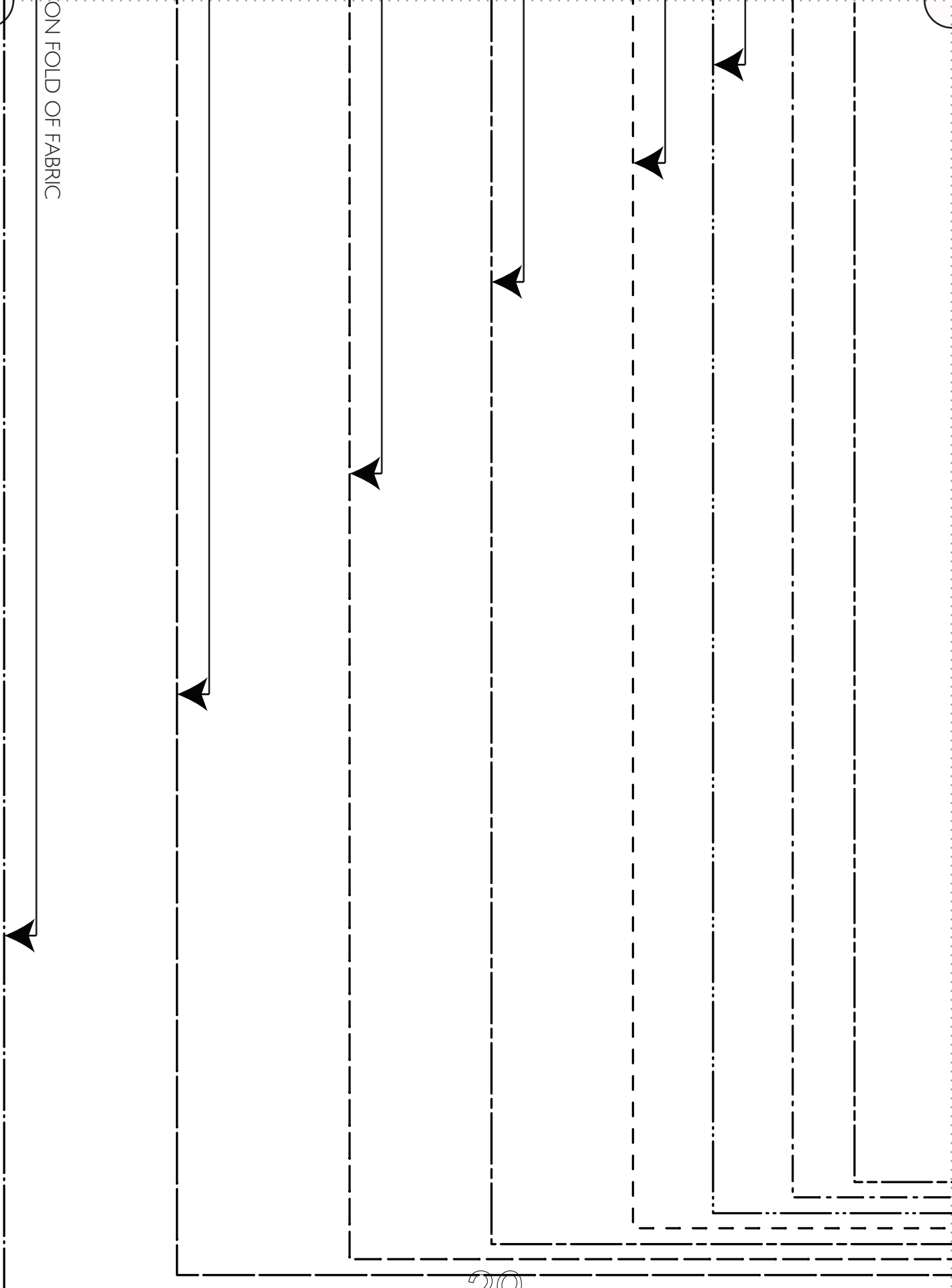

All Seam Allowances

Main:

Skirt:

Pocket:

Pocket:

Allowances Included

- Seams: 3/8"
- Hem: 1.5"
- Band Flap: 1/4"
- Net Hem: 1/2"

F|S
FABRICS-STORE.COM

“Sky”
Sleeve placket – cut 2 on the bias grain

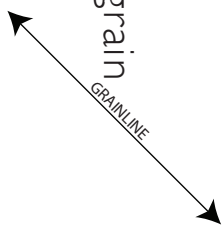

SIZE 0/2

SIZE 4/6

SIZE 8/10

SIZE 12/14

SIZE 16/18

SIZE 20/22

SIZE 24/26

SIZE 28/30

All Seam Allowances Included

Main seams: 3/8"

Skirt Hem: 1.5"

Pocket and Flap: 1/4"

Pocket Hem: 1/2"

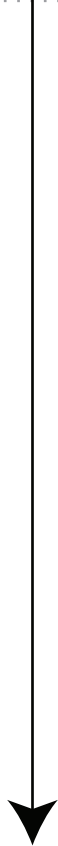

SLIT

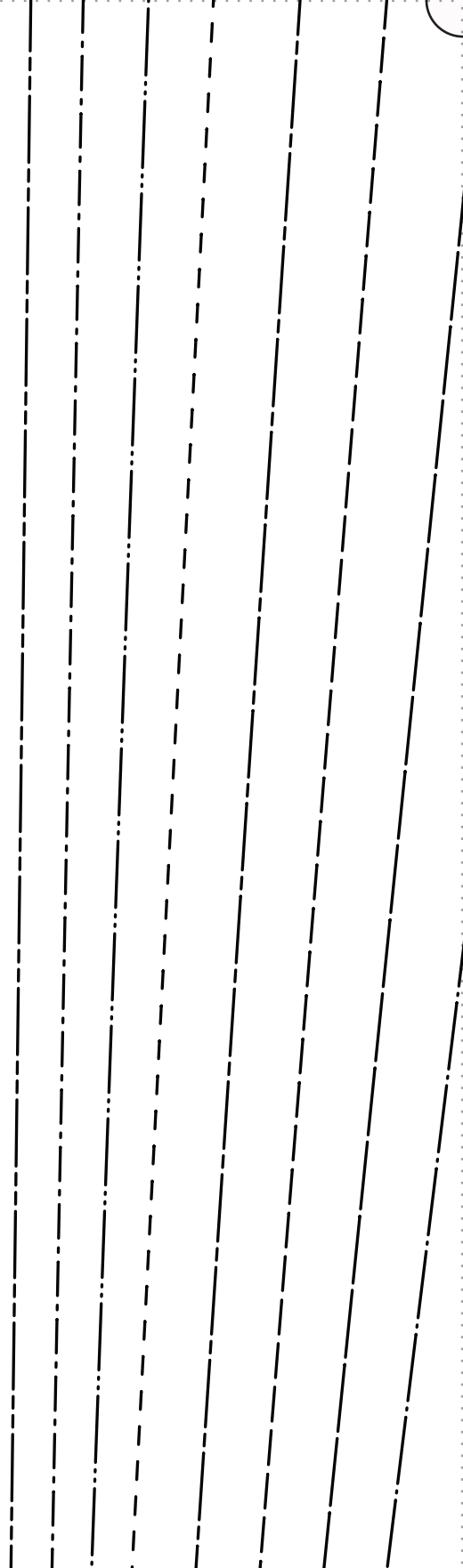

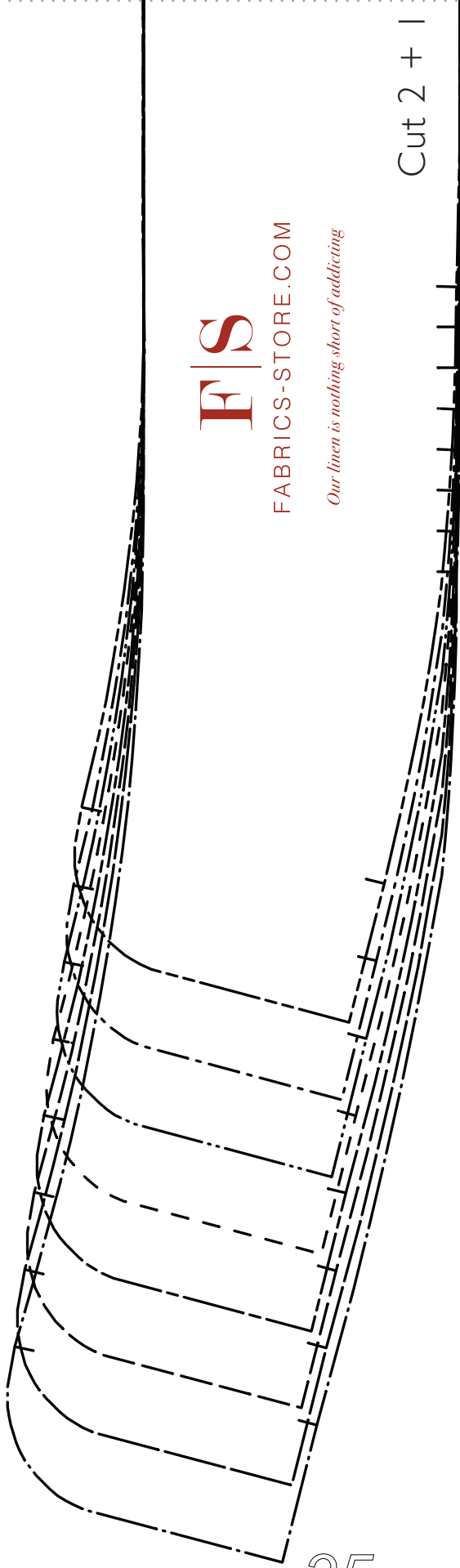

F|S
FABRICS-STORE.COM

Our linen is nothing short of addicting

Cut 2 + 1

- SIZE 0/2 _____
- SIZE 4/6 _____
- SIZE 8/10 _____
- SIZE 12/14 _____
- SIZE 16/18 _____
- SIZE 20/22 _____
- SIZE 24/26 _____
- SIZE 28/30 _____

F|S
FABRICS-STORE.COM
Our linen is nothing short of addicting

“Sky”
#FabricStoreSkyPattern

Thank you

*We work hard on making our patterns beautiful
enough to meet your standards.*

*If you feel like sharing praise or helpful criticism, please
send us your comments to ask@fabrics-store.com*